



PRODUCT FEATURES KSA

- For natural ventilation, SHEV und ferralux® NRWG nach EN12101-2
- TWIN versions with two chains and doubled force
- Adjustable chain tension
- Mechanical chain unlocking
- Aluminium housing anodized or optionally in RAL colors
- High-quality stainless steel roller chain
- Programmable parameters of Intelligent Control Electronics S12:
 - Synchronised multi-operation and sequence control without add. devices
 - Electronic soft-start, soft-close and soft-stop at end of stroke control
 - Stroke, force, speed
 - Rebate control
- Integrated plug solution
- Compatible with the plug-in configuration modulel M-COM® Click

For this product series, a Type III Environmental Product Declaration (EPD) was issued according to ISO 14025 and EN 15804. The LCA results of the different product types are listed at the end of this product catalogue. The EPD documents can be viewed or downloaded from our homepage www.aumueller-gmbh.de.

FACADE

Bottom-hung

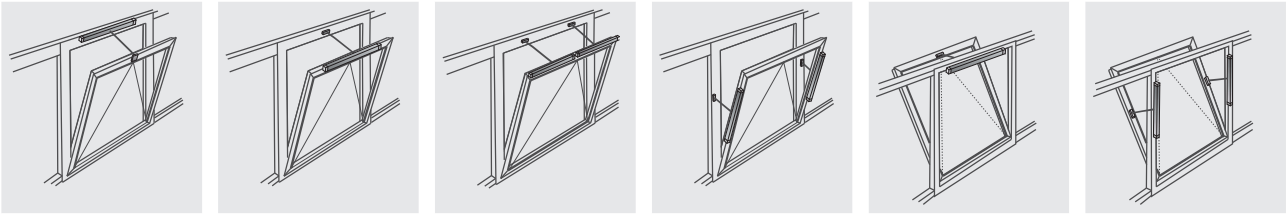

Top-hung

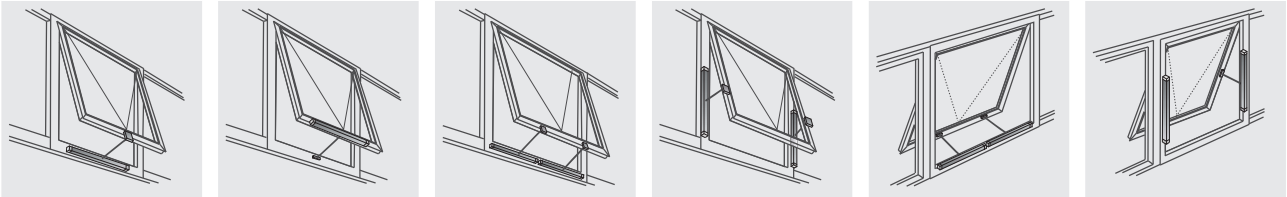

Side-hung

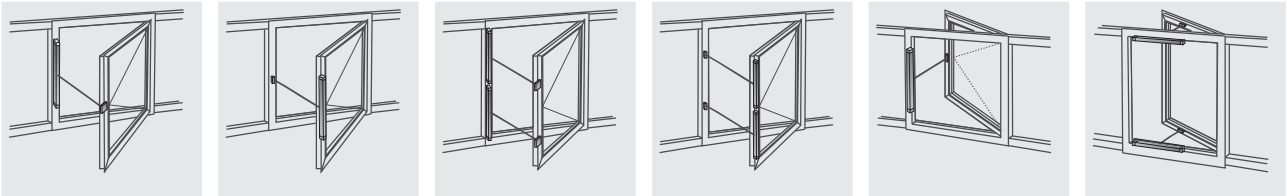

Friction hinged

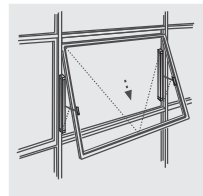
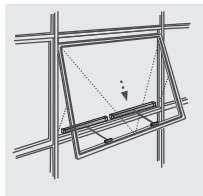
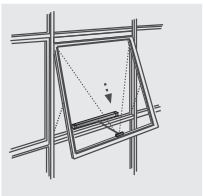

Parallel outward opening



ROOF

Bottom-hung

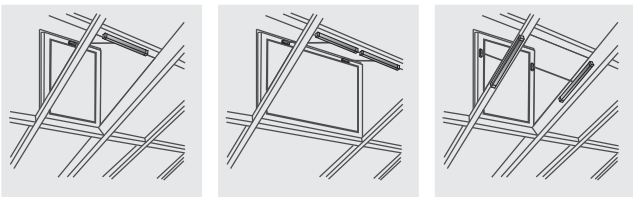

Top-hung

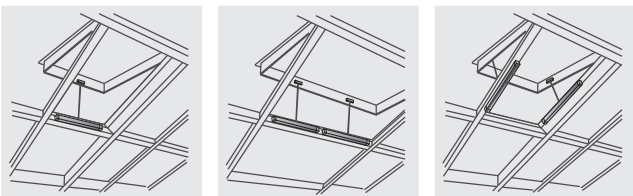

Sky light

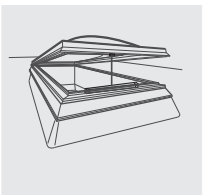

Glass pyramid

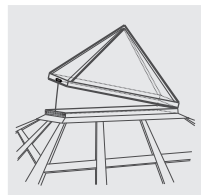



- Application: natural ventilation, SHEV, ferralux®-NSHEV
- Internal Intelligent Control Electronics S12
- Adjustable chain tension / Mechanical chain unlocking

Equipment

- Additional **AUMÜLLER-Click plug set** for multi-drive operation

Options

- Programmable special functions
- M-COM for automatic synchronised run of multi drive systems and automatic sequence control with locking drives (S3 / S12)

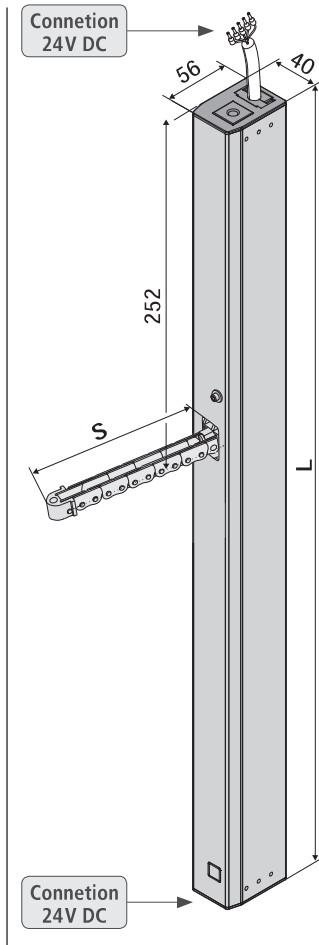

TECHNICAL DATA

U_N	Rated voltage	24V DC (19 V ... 28 V)
I_N	Rated current	0,9 A
I_A	Cut-off current	1,2 A
P	Rated power	22 W
DC	Duty cycle	5 cycles (ED 30 % - ON: 3 min./OFF: 7 min.)
	Protection rating	IP 32
	Ambient temperature range	-5 °C ... +60 °C
F	Pulling force max.	600 N
F_A	Pushing force max.	

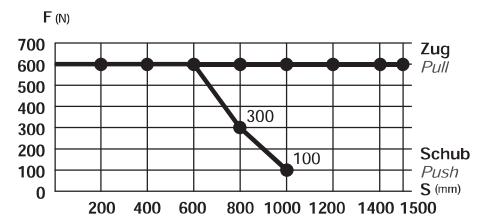

s > 800 mm only for pulling application

Pullout force	3.000 N (fastening depended)									
Chain	stainless steel									
Connecting cable	non-halogen, grey 5 x 0,5 mm ² , ~ 3 m									
Speed	<table border="0"> <tr> <td>s < 400</td> <td> 8,0 mm/s</td> <td> 8,0 mm/s</td> </tr> <tr> <td>s 500 – 600</td> <td> 12,0 mm/s</td> <td> 8,0 mm/s</td> </tr> <tr> <td>s > 600</td> <td> 13,5 mm/s</td> <td> 8,0 mm/s</td> </tr> </table>	s < 400	8,0 mm/s	8,0 mm/s	s 500 – 600	12,0 mm/s	8,0 mm/s	s > 600	13,5 mm/s	8,0 mm/s
s < 400	8,0 mm/s	8,0 mm/s								
s 500 – 600	12,0 mm/s	8,0 mm/s								
s > 600	13,5 mm/s	8,0 mm/s								
S	Stroke	250 – 1.500 mm								
L	Length	see order data								
	Sound pressure level	≤ 70 dB (A)								

In delivery

- 1 2x countersunk screws M8x16 and 2x Spacer ring (brass)
- 2 2x blind plug for unused cable entry
- 3 1x chain unlocking key
- 4 1x **AUMÜLLER-Click plug set** (24V) for multi-drive operation
- 5 1x warning sign sticker „Risk of entrapment“

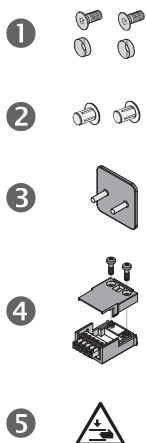

ORDER DATA						
s [mm]	L [mm]	Version	Finish	PU / pcs.	Part.-No.	
250	515	KSA 250 S12 24V	E6/C-0	1	522725	
300	591	KSA 300 S12 24V	E6/C-0	1	522730	
400	591	KSA 400 S12 24V	E6/C-0	1	522740	
500	693	KSA 500 S12 24V	E6/C-0	1	522750	
600	693	KSA 600 S12 24V	E6/C-0	1	522760	
800	794	KSA 800 S12 24V	E6/C-0	1	522780	
1000	896	KSA 1000 S12 24V	E6/C-0	1	522810	
1200	998	KSA 1200 S12 24V	E6/C-0	1	522812	
1500	1151	KSA 1500 S12 24V	E6/C-0	1	522815	

OPTIONS						
Special model	PU / pcs.	Part.-No.				
Drive housing painted/powder coated in other RAL colours						
Lump sum for coating		516030				
Specify at order stage:	1 – 20	516004				
	21 – 50	516004				
	51 – 100	516004				
	from 101	516004				
Plug solution:						
AUMÜLLER-Click plug solution - 5 m – non-halogen, grey – 5 x 0,5 mm²		501252				
AUMÜLLER-Click plug solution - 10 m – non-halogen, grey – 5 x 0,5 mm²		501253				
Microprocessor programming S12						
Electronic stroke reduction 24V S12		524190				
Programming drives 24V / 230V S12		524180				
Optional accessories						
M-COM® Click Configuration module for synchronised multi-drive systems	1	524167				
M-COM Configuration module for synchronised multi-drive systems	1	524177				



- Application: natural ventilation, SHEV, ferralux®-NSHEV
- Internal Intelligent Control Electronics S12
- Adjustable chain tension / Mechanical chain unlocking
- Programmable feedback limit position „OPEN“ and „CLOSE“ (max. 24V, 500 mA)

Equipment

- Additional **AUMÜLLER-Click plug set** for multi-drive operation

Options

- Programmable special functions
- M-COM for automatic synchronised run of multi drive systems and automatic sequence control with locking drives (S3 / S12)

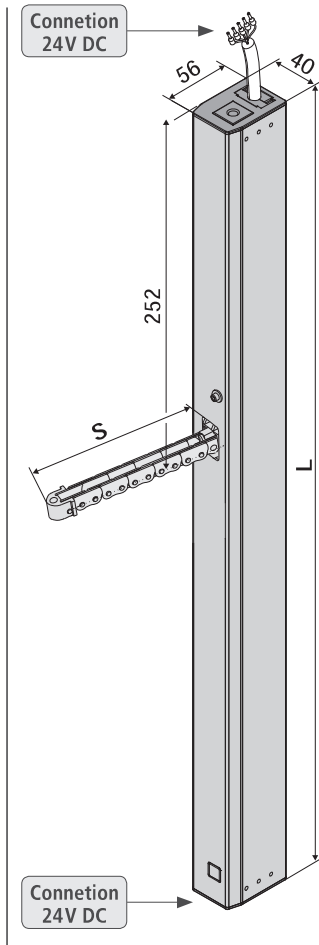

TECHNICAL DATA

U_N	Rated voltage	24V DC (19 V ... 28 V)
I_N	Rated current	0,9 A
I_A	Cut-off current	1,2 A
P	Rated power	22 W
DC	Duty cycle	5 cycles (ED 30 % - ON: 3 min./OFF: 7 min.)
	Protection rating	IP 32
	Ambient temperature range	-5 °C ... +60 °C
F	Pulling force max.	600 N
F_A	Pushing force max.	

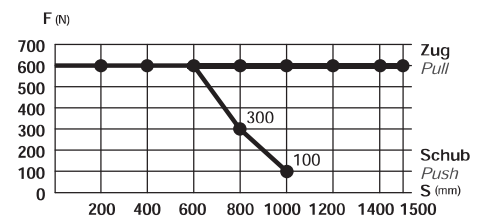

s > 800 mm only for pulling application

Pullout force	3.000 N (fastening depended)									
Chain	stainless steel									
Connecting cable	non-halogen, grey 5 x 0,5 mm ² , ~ 3 m									
Speed	<table border="0"> <tr> <td>s < 400</td> <td> 8,0 mm/s</td> <td> 8,0 mm/s</td> </tr> <tr> <td>s 500 – 600</td> <td> 12,0 mm/s</td> <td> 8,0 mm/s</td> </tr> <tr> <td>s > 600</td> <td> 13,5 mm/s</td> <td> 8,0 mm/s</td> </tr> </table>	s < 400	8,0 mm/s	8,0 mm/s	s 500 – 600	12,0 mm/s	8,0 mm/s	s > 600	13,5 mm/s	8,0 mm/s
s < 400	8,0 mm/s	8,0 mm/s								
s 500 – 600	12,0 mm/s	8,0 mm/s								
s > 600	13,5 mm/s	8,0 mm/s								

S	Stroke	250 – 1.500 mm
L	Length	see order data
	Sound pressure level	≤ 70 dB (A)

In delivery

- 2x countersunk screws M8x16 and 2x Spacer ring (brass)
- 2x blind plug for unused cable entry
- 1x chain unlocking key
- 1x **AUMÜLLER-Click plug set** (24V) for multi-drive operation
- 1x warning sign sticker „Risk of entrapment“

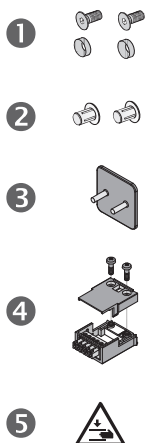

ORDER DATA						
s [mm]	L [mm]	Version	Finish	PU / pcs.	Part.-No.	
250	515	KSA 250 S12 24V Z	E6/C-0	1	522723	
300	591	KSA 300 S12 24V Z	E6/C-0	1	522733	
400	591	KSA 400 S12 24V Z	E6/C-0	1	522743	
500	693	KSA 500 S12 24V Z	E6/C-0	1	522753	
600	693	KSA 600 S12 24V Z	E6/C-0	1	522763	
800	794	KSA 800 S12 24V Z	E6/C-0	1	522783	
1000	896	KSA 1000 S12 24V Z	E6/C-0	1	522813	
1200	998	KSA 1200 S12 24V Z	E6/C-0	1	522823	
1500	1151	KSA 1500 S12 24V Z	E6/C-0	1	522853	

OPTIONS						
Special model		PU / pcs.	Part.-No.			
Drive housing painted/powder coated in other RAL colours						
Lump sum for coating				516030		
Specify at order stage:		1 – 20		516004		
		21 – 50		516004		
		51 – 100		516004		
		from 101		516004		
Plug solution:						
AUMÜLLER-Click plug solution - 5 m – non-halogen, grey – 5 x 0,5 mm²				501252		
AUMÜLLER-Click plug solution - 10 m – non-halogen, grey – 5 x 0,5 mm²				501253		
Microprocessor programming S12						
Electronic stroke reduction 24V S12				524190		
Programming drives 24V / 230V S12				524180		
Optional accessories						
M-COM® Click Configuration module for synchronised multi-drive systems			1	524167		
M-COM Configuration module for synchronised multi-drive systems			1	524177		